

SCX2 SERIES Commercial Lighting

SCX2-6FT-60W-MCT4-D-TR
TRACK LIGHT

WESTGATE
THE FUTURE IS HERE...AND IT'S QUITE BRIGHT!

Customer Name: _____

Project Name: _____

Note: _____

Type: _____



MCT

Custom:



Selection:

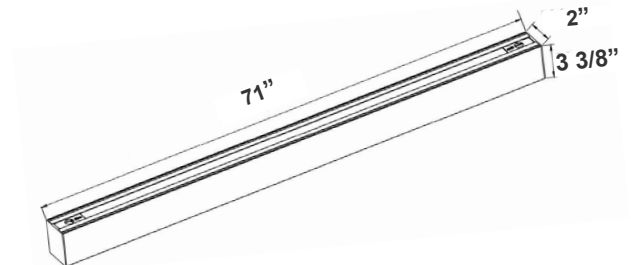

71"(L) x 2"(W) x 3 3/8"(H)

A member of the SCX family of Superior Linear Lights. A most comprehensive selection of linear lighting for all applications. Ideal for, retail locations, offices, lobbies, conference rooms, reception areas, hallways, educational facilities, hotels, and restaurants.

Features

- LED Superior Architectural Lights
- Seamless Linkable Linear Lighting System
- Opal Polycarbonate Lens-Direct (DOWN) Lighting
- Optional Recessed & Wall Mounting Kits Available
- Optional Louver Version Lens Available
- Lens Type: Opal Polycarbonate Lens
- MCT: Multi Color Temperature (Selectable Switch Inside Fixture)

Technical Specifications

Electrical:

- Voltage: 120-277VAC 50/60Hz
- Wattage: 60W
- Power Factor: >0.95
- LWP: 96/ 104/ 101/ 104
- Total Harmonic Distortion: $\leq 20\%$

Mechanical:

- Low Profile Modern Design
- Aluminum Housing With Matte White Finish
- Custom Colors Available
- Lens Snaps into Housing
- Track is not included. Fits HALO™ & Compatible Systems
- Make Different Connections Via T/L/X Joints on Both Ends
- Mounting Options: Surface, Suspended, Wall, Recessed
- IP Rating: IP54
- Operating Temperature: -13°F~104°F
- Adjustable Suspension Brackets Provided on Top of The Fixtures

Lighting:

- Dimmable: 0~10V Dimming
- Total Lumens: 5814LM/ 6228LM/ 6081LM/ 6265LM
- Color Temperatures: 3000K/3500K/4000K/5000K
- Multi-CCT(Selectable Switch Inside Fixture)
- Color Rendering Index: CRI ≥ 80
- Up Light Option Available
- 50,000 Hours Rated Life
- 5-Year Warranty
- Beam Angle: 104.8°(H) x 100.5°(V)

Applications:

- Ideal for offices, hotels, corridors, saloons, libraries, meeting rooms, conference halls, and the best solution for modern lighting solutions
- It can be used in any indoor applications

Other Models:

• 20W | 2084LM | SCX2-2FT-20W-MCT4-D-TR • 30W | 3133LM | SCX2-3FT-30W-MCT4-D-TR • 40W | 4179LM | SCX2-4FT-40W-MCT4-D-TR • 80W | 8359LM | SCX2-8FT-80W-MCT4-D-TR



Phone: (877) 805-2252 | Fax: (877) 805-2252
www.westgatemfg.com |



Photometrics: SCX2-6FT-MCT4

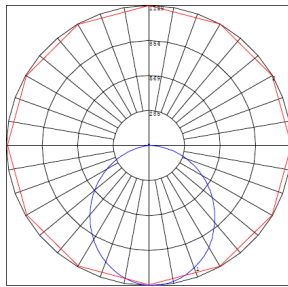
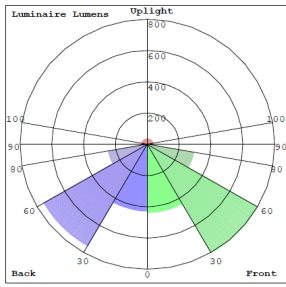

BUD Rating: B1-U2-G1

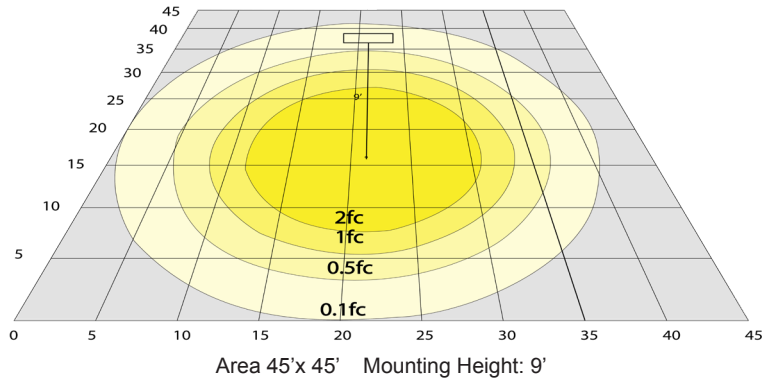

Other Views:



Side View



Front View

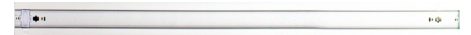

Back View

Performance Table: SCX2-6FT-MCT4

MODEL NO.	Wattage	Voltage	Lumens	Color Temp.	BUG Rating	LPW
SCX2-6FT-60W-MCT4-D	60W	120~277V	5814LM	3000K	B1-U2-G1	96
			6228LM	3500K		104
			6018LM	4000K		101
			6265LM	5000K		104

Sample Ordering

Model	Size	Wattage	Color Temp.	Feature
SCX2	6FT	60W	MCT4	D

Accessories:

Blank = No Option For Accessories

SCL-CS1-6FT = ADJ. 6FT 1/16in SINGLE SUSPENSION CANOPY SET WITH KEYHOLE END CONNECTOR, NON-POWER SIDE

SCL-CS1P-6FT = ADJ. 6FT 1/16in SINGLE SUSPENSION CANOPY SET WITH KEYHOLE END CONNECTOR, POWER SIDE WITH SJTW18/5 WHITE CORD

SCL-CS1P-6FT-NC = ADJ. 6FT 1/16in SINGLE SUSPENSION CANOPY SET WITH KEYHOLE END CONNECTOR

SCL-GS10 = ADJ. 10FT 1/16in DOUBLE SUSPENSION CABLE WITH SINGLE KEYHOLE CONN., LOOP GRIPPER ON TOP

SCL-GS20 = ADJ. 20FT 1/16in DOUBLE SUSPENSION CABLE WITH SINGLE KEYHOLE CONN., LOOP GRIPPER ON TOP

SCL-6FT-SJTW18/5 = 6ft White Cord, SJTW 18 AWG 5-Conductor (Black, White, Green + Purple & Gray for 0-10V Dimming)

SCL-6FT-SJTW18/5-100FT = 100ft Roll of White Cord, SJTW 18 AWG 5-Conductor (Black, White, Green + Purple & Gray for 0-10V Dimming)

SCL-6FT-SJTW18/5-100FT-BK = 100ft Roll of Black Cord, SJTW 18 AWG 5-Conductor (Black, White, Green + Purple & Gray for 0-10V Dimming)

SCL-6FT-SJTW18/6-100FT = 100ft Roll of Black Cord, SJTW 18 AWG 6-Conductor (Black, White, Green + Purple & Gray for 0-10V Dimming + Red for Backup Inverter)

SCL-AH = Heavy-Duty Auxiliary Hook for Up To 1/16" Aircraft Cable

SCL-ASC-500FT = 1/16" 500 ft. Steel Aircraft Cable Suspension

* More Mounting Options Refer to page 4

Factory-Installed Options:

Blank = No Option For Accessories

OPT-HBC-125BS-WH = 10FT, 15A, 125V, 18/3 STR, WHT

* More Factory-Installed Options Refer to page 6

SUSPENDED MOUNTING ACCESSORIES (NOT INCLUDED)



SCL-CS1-6FT SCL-CS1P-6FT SCL-CS1P-6FT-NC SCL-GS10 SCL-GS20



SCL-6FT-SJTW18/5-100FT
SCL-6FT-SJTW18/6-100FT



SCL-6FT-SJTW18/5-100FT-BK



SCL-ASC-500FT



SCL-AH



SCL-ASC-500FT



SCL-6FT-SJTW18/5

FACTORY-INSTALLED OPTIONS:



OPT-HBC-125BS-WH

Example:

- SCX2-6FT-60W-MCT4-D (For SCX2 60W MCT4 fixture 120-277V)
- SCX2-6FT-60W-MCT4-D OPT-HBC-125BS-WH (For SCX2 60W MCT4 fixture 120-277V (10FT, 15A, 125V, 18/3 STR, WHT))



MOUNTING AND MODULES OPTIONS:



Recessed Mounted
(Flanged)



Surface Mounted

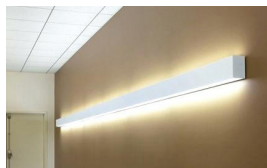

Wall Mounted



Suspended



T-Bar Installation

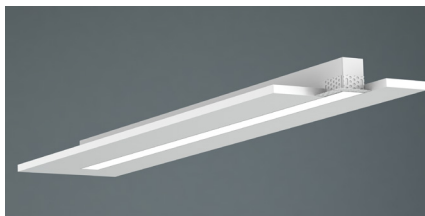

Flangless Recessed Mounted
(Mud-In)

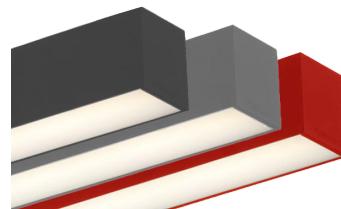

Color of Your Choice



L Module
(page 7)

SCX2-L-MCT4

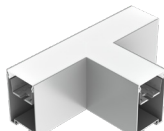

T Module
(page 7)

SCX2-T-MCT4



X Module
(page 7)

SCX2-X-MCT4



Inside Corner Module
(page 7)

SCX2-IC-MCT4

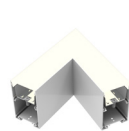

C60 Module
(page 7)

SCX2-C60-MCT4



Outside Corner
Module
(page 7)

SCX2-OC-MCT4

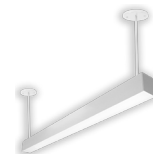

Suspension Rod Kit

SCL-RS-12 12"
SCL-RS-18 18"
SCL-RS-24 24"
SCL-RS-36 36"
SCL-RS-48 48"

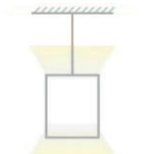

Up Light Option

3000K
3500K
4000K
5000K
Blue
Green



MOUNTING OPTIONS:

FLANGLSS RECESSED INSTALLATION IN WOOD CEILING

No additional accessories required.

Make recessed preparations by installing a horizontal plank of wood on top of the wood ceiling at a recessed height of 3 3/8".

Screw and anchor kit provided with each fixture can be used to fasten the top of the fixture to the wood plank through the holes on top of the fixture.

You can also install vertical wood boards on top of the ceiling at the edge of the opening and open the fixture and put screws through the side of the fixture housing to fasten it to the wood boards.

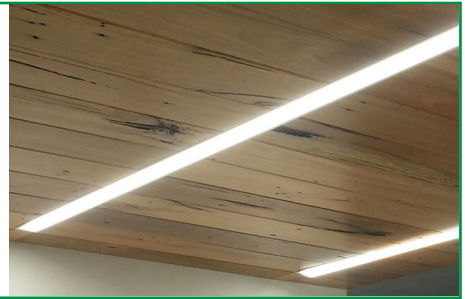

SUSPENSION ROD KITS (SET OF 2)

Model	SIZE
SCL-RS-12	12 IN
SCL-RS-18	18 IN
SCL-RS-24	24 IN
SCL-RS-36	36 IN
SCL-RS-48	48 IN

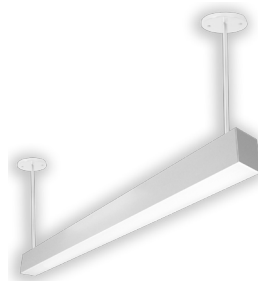

WALL MOUNTING

Model	DESCRIPTION
OPT-SCX-WM-6FT	Install this optional wall mounting brackets on the back of the fixture. Connection cables will enter the fixture through one of these wall-mounting brackets. On your purchase order, please specify the position of where your wire entry from the wall.

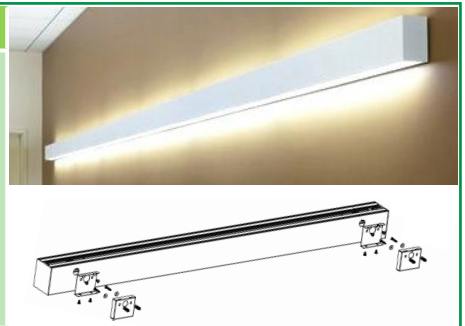

WALL MOUNTING

Model	DESCRIPTION
OPT-SCX-WMA-6FT	Add this option to the fixture, and wall mounting arms with a wall canopy will be installed on the back of the fixture. The length of each arm is 5". Connection cables will enter the fixture through one of the arms. On your purchase order, specify the position of your wire entry from the wall, and the arm will be installed on the back accordingly.

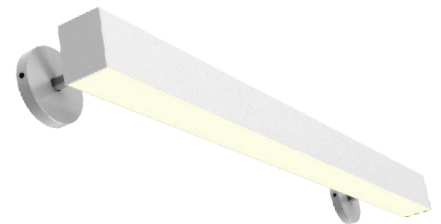

RECESSED MOUNT WITH FLANGE

Model	DESCRIPTION
OPT-SCX-FMR-6FT	Order this option and the fixture will be equipped with a 1/2" wide flange on four sides. Advanced design toggle-style brackets will also be provided, to adjust and hold the fixture against drywall or other hard ceilings from the top. When linking to another fixture or corner module, call us or send a copy of your plan along with your PO, and flanges will be removed on those ends that need to make a seamless connection.

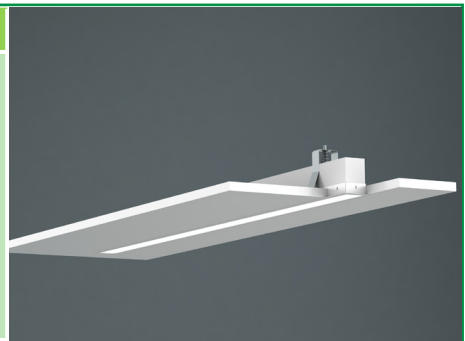

LINKING

Model	DESCRIPTION
OPT-SCX-LINKWIRING	Fixtures are equipped with pre-installed linking brackets and accessories and only need to be wired together. to receive a fixture prewired for linking, order the option below for each link to another fixture or a corner module.

FLANGELESS RECESS MOUNT IN DRYWALL (MUD-IN)

Model	DESCRIPTION	
OPT-SCX-MIF-6FT	Order this option and the fixture will be equipped with mud-in brackets on all four sides, mounted at 1/16" from the lens surface (specify if other spacing is needed). Advanced design toggle-style brackets will also be provided, to adjust and hold the fixture against the drywall ceiling from the top. When linking to another fixture or corner fixture module call us or send a copy of your plan along with your PO and flanges will be removed on those end that needs to make a seamless connection.	
OPT-SCX-MIF-L	This is a L Module option.	
OPT-SCX-MIF-T	This is a T Module option.	
OPT-SCX-MIF-X	This is a X Module option.	
OPT-SCX-MIF-IC	This is a Inside Corner Module option.	

SURFACE MOUNTING

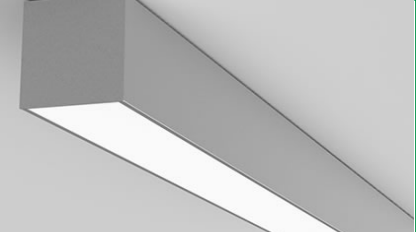
<p>No additional accessories required.</p> <p>Screw and anchor kit provided with each fixture can be used to fasten the fixture directly to the hard surface through the holes on top of the fixture.</p>	
---	---

LIGHTS SCX FLEXIBLE LENS ROLL 25FT OR 100FT

Model	SIZE	DESCRIPTION	
SCX2-FLEXLENS-25FT	25FT	Flex lenses can be cut to different lengths, enabling precise customization according to the installation area. This allows for a seamless fit, reducing gaps or visible transitions between different sections of the SCX lights	
SCX2-FLEXLENS-100FT	100FT		

FACTORY-INSTALLED OPTIONS:

COLOR OF YOUR CHOICE

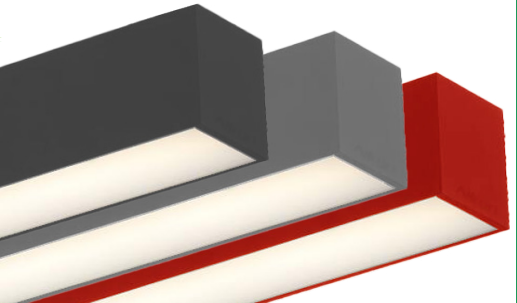
Model	DESCRIPTION	
OPT-SCX-CLR-6FT	Add this option and specify your desired color on your purchase order or provide a swatch to match. For painted flanged fixture or optional rod, mounting set please also add the relevant option below for each fixture.	
OPT-SCX-CLR-FRM	This is a painted flanges option.	
OPT-SCX-CLR-RODSET	This is a painted rod set option.	



INDIRECT (UP) LIGHTING

Model	WATTS	LUMENS	COLOR TEMP	SIZE
OPT-SCX-ULM-6FT-24W-MCT4	24W	2400LM	3000K	6FT
		2472LM	3500K	
		2520LM	4000K	
		2592LM	5000K	
OPT-SCX-ULM-BU	Indirect (up) light with blue color			
OPT-SCX-ULM-GR	Indirect (up) light with green color			



EMERGENCY BATTERY BACKUP

Model	DESCRIPTION
OPT-EM-CM1INT	This is an option for a 90-minute backup battery installation. If you need to order this series for the fixture, please have your purchase order ready and call us or specify on the order which fixture to install this option and the test button.

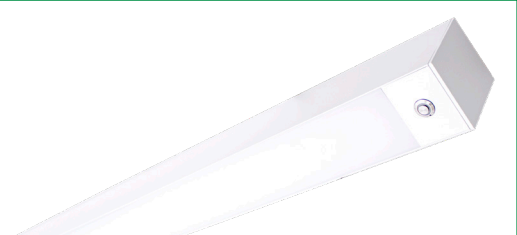

BI-LEVEL MOTION SENSOR

Model	DESCRIPTION
OPT-SEN-SCX2	This option installs an advanced motion sensor that will turn the lights on when the area is occupied. When the area is cleared, after a preset hold time of 5 sec or more the lights are dimmed to a standby level of 30% or more. If still no motion is detected, after the standby period, the light is turned off. All setting is programmable with a remote control.
OPT-WEC-3RC	This is an optional remote control for sensor.



DEDICATED WIRING FOR UPLIGHT CONTROL

Model	DESCRIPTION											
OPT-SCX-ULC-6FT-MCT4	Dedicated Wiring For Uplight Control By Installing A Separate Electrical Circuit And Compatible Driver For Uplighting. This Ensures Independent Control And Power Management. A Driver Regulates The Voltage And Current Supplied To The Uplights, Allowing For Precise Brightness And Color Control, Often Through A Dimmer Or automation System.											
	<table border="1"> <thead> <tr> <th>WATTS</th> <th>LUMENS</th> <th>COLOR TEMP</th> <th>SIZE</th> </tr> </thead> <tbody> <tr> <td rowspan="4">24W</td> <td>2400LM</td> <td rowspan="4">3000K 3500K 4000K 5000K</td> <td rowspan="4">6FT</td> </tr> <tr> <td>2472LM</td> </tr> <tr> <td>2520LM</td> </tr> <tr> <td>2592LM</td> </tr> </tbody> </table>	WATTS	LUMENS	COLOR TEMP	SIZE	24W	2400LM	3000K 3500K 4000K 5000K	6FT	2472LM	2520LM	2592LM
	WATTS	LUMENS	COLOR TEMP	SIZE								
	24W	2400LM	3000K 3500K 4000K 5000K	6FT								
		2472LM										
2520LM												
2592LM												

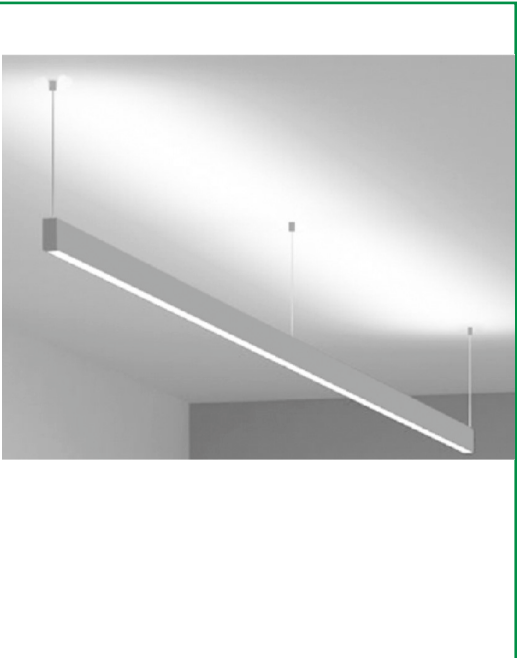

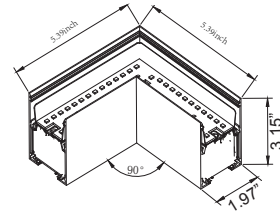
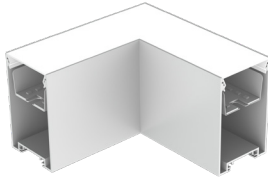

CORNER FIXTURE MODULES:

Built-in LED Modules

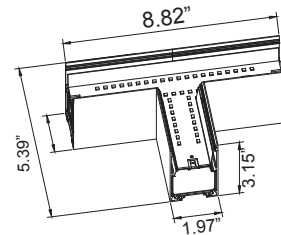
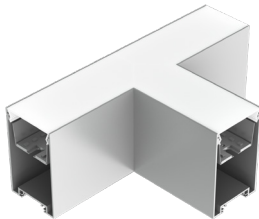

Model	JOINT TYPE	LUMENS	COLOR TEMP	DIMENSION
SCX2-L-MCT4	L	508LM 575LM 616LM 660LM	3000K 3500K 4000K 5000K	5.39" X 5.39" X 3.15" X 1.97"



Model	JOINT TYPE	LUMENS	COLOR TEMP	DIMENSION
SCX2-T-MCT4	T	629LM 726LM 787LM 854LM	3000K 3500K 4000K 5000K	8.82" X 5.39" X 3.15" X 1.97"

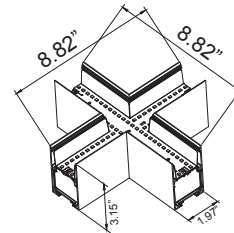
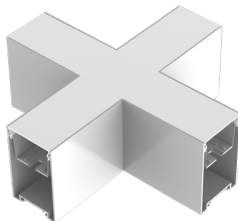

Model	JOINT TYPE	LUMENS	COLOR TEMP	DIMENSION
SCX2-X-30K	X	733LM 863LM 944LM 1037LM	3000K 3500K 4000K 5000K	8.82" X 8.82" X 3.15" X 1.97"

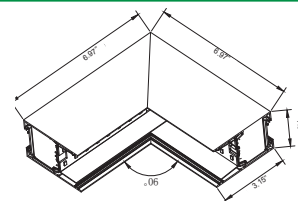
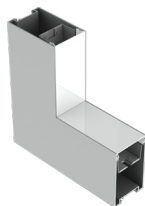

Model	JOINT TYPE	LUMENS	COLOR TEMP	DIMENSION
SCX2-IC-MCT4	INSIDE CORNER	629LM 726LM 787LM 854LM	3000K 3500K 4000K 5000K	6.97" X 6.97" X 1.97" X 3.15"



CORNER FIXTURE MODULES:

Built-in LED Modules

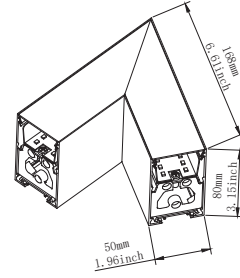

Model	JOINT TYPE	LUMENS	COLOR TEMP	DIMENSION
SCX2-C60-MCT4	C60	508LM 575LM 616LM 660LM	3000K 3500K 4000K 5000K	6.16" X 3.15" X 1.97"

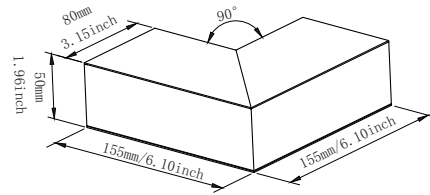
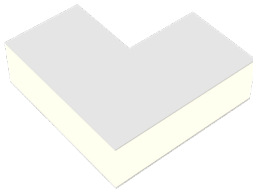

Model	JOINT TYPE	LUMENS	COLOR TEMP	DIMENSION
SCX2-OC-MCT4	Outside Corner	629LM 726LM 787LM 854LM	3000K 3500K 4000K 5000K	6.1" X 6.1" X 3.15" X 1.96"

WOOD TRIMS

Model	DESCRIPTION
OPT-SCX2-WK02-6FT-MAPLE	6FT MAPLE FINISH
OPT-SCX2-WK02-6FT-WALNUT	6FT WALNUT FINISH
OPT-SCX2-WK02-6FT-FREOAK	6FT FRENCH OAK FINISH
OPT-SCX2-WK02-6FT-EBONY	6FT EBONY FINISH

MAPLE

WALNUT

FRENCH OAK

EBONY

SCX INSTALLED ACOUSTIC OPTIONS

Model	DESCRIPTION
OPT-SCX-AK-6FT-9MM-HY2210	9mm Fiber Acoustic Kit, Dark Blue
OPT-SCX-AK-6FT-9MM-HY2204	9mm Fiber Acoustic Kit, Dark Gray



COLOR CHART: * Choose from one of our Premium Colors with no set-up fee.

Gloss:



SILVER METALLIC
70 GLOSS
T357-GR105



SILVER METALLIC
30 GLOSS
T353-GR06



DARK RED 90
GLOSS
P009-RD02



INTERNATIONAL
ORANGE 90
GLOSS
T009-OG26



SAFETY ORANGE
90 GLOSS
T009-OG01



YELLOW 90
GLOSS
T009-YL14



YELLOW 90
GLOSS
T009-YL01



TRAFFIC GREEN
70 GLOSS
T007-GN16



GREEN 70 GLOSS
T007-GN13



GREEN 60 GLOSS
C006-GN03



BLUE 90 GLOSS
T009-BL01



DARK BLUE 80
GLOSS
T008-BL20



RAL 8028 TERRA
BROWN 90 GLOSS
C209-BR358

Hammer:



WHITE HAMMER
T013-WH09



BEIGE HAMMER
T013-BG38



GREY HAMMER
C013-GR08

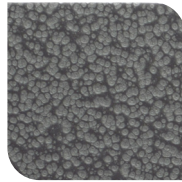

SILVER
HAMMERTONE
T064-GR05



BLACK HAMMER
T013-BK62



RED HAMMER
T013-RD15



GREEN HAMMER
T013-GN20

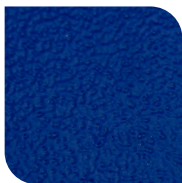

BLUE HAMMER
T013-BL468



BRONZE HAMMER
T012-BR161

Texture:



WHITE TEXTURE
C031-WH120



FLINT GRAY
TEXTURE
T243-GR522



BLACK TEXTURE
C241-BK109



RED TEXTURE
T241-RD129



BLUE TEXTURE
C241-BL544

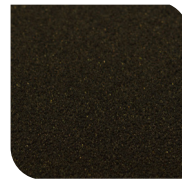

OIL RUBBED
BRONZE TEXTURE
T291-BR251

Vein:



BLACK/WHITE
VEIN
T075-WH34

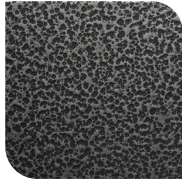

SILVER VEIN
T375-BK26

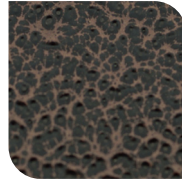

COPPER VEIN
EXTERIOR
T075-BK211



GOLD VEIN
T375-BK10



COPPER VEIN
T375-BK07

